

MFC PEDESTALS

— By Actiu —

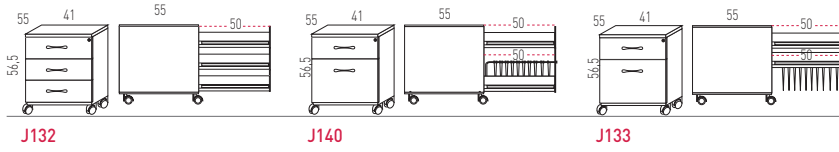

Mobile pedestal with metal runners



Mobile pedestals with metal runners with wheels

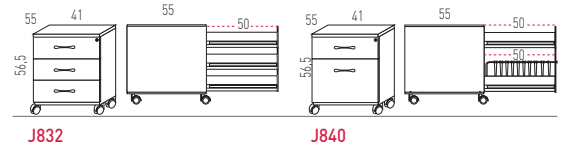

Mobile pedestal with metal runners.
Metal drawers with total extraction.

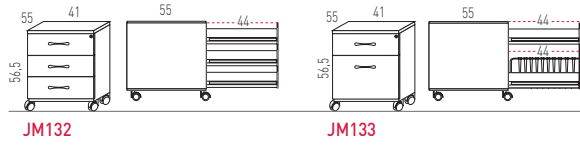

Mobile pedestals with metal runners and top cushion

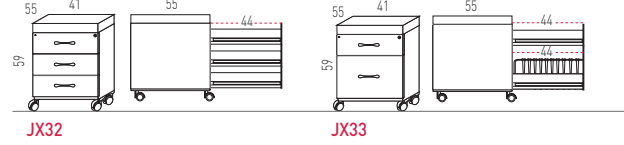

Mobile pedestals with metal runners. Model with and without top cushion

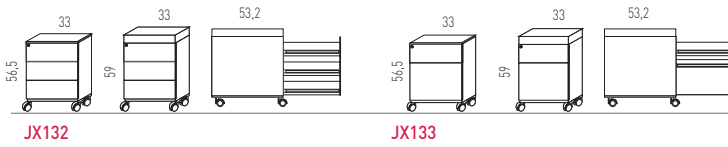

Auxiliary mobile pedestal with metal runners

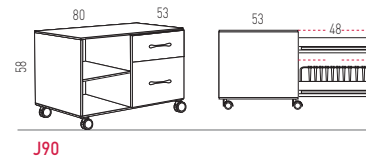

Desk height pedestals with metal runners - height 29" 9/64

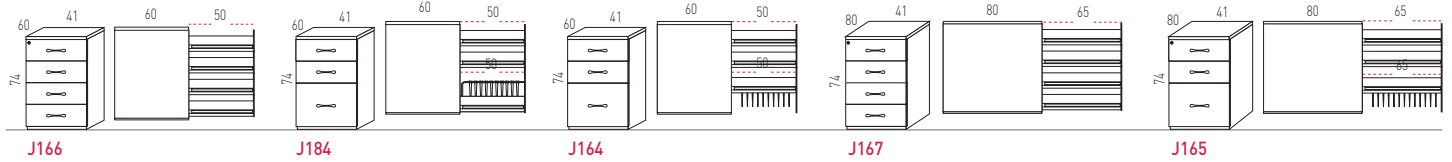

Desk-support credenza unit

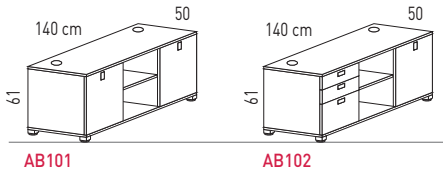

Pull out pedestals with metal drawer and runners - 24" 1/8 height

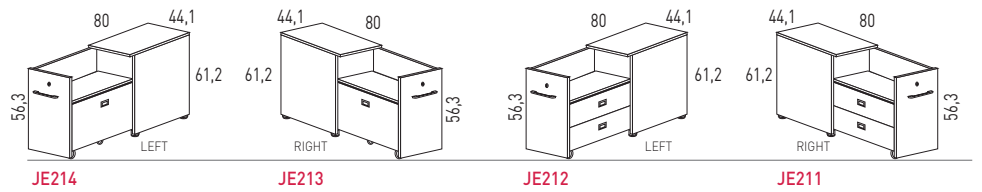

Pull out pedestals with metal drawer and runners - 44" 1/2 height

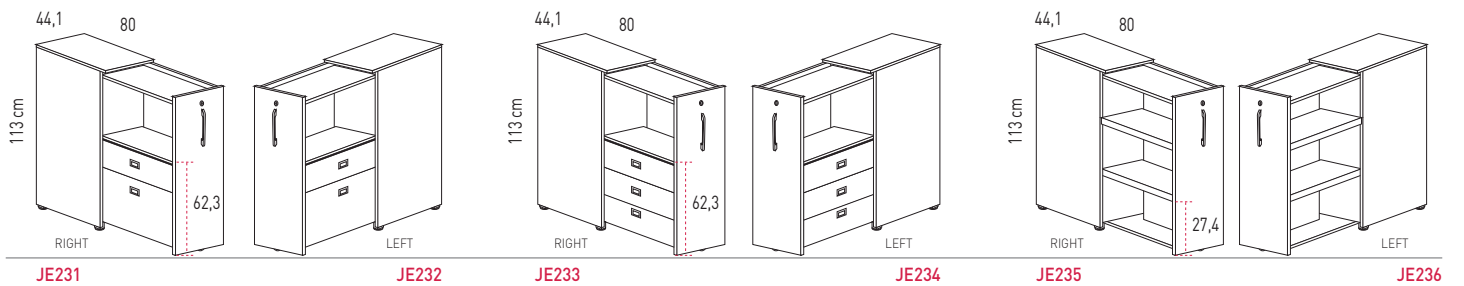

Hutch for pedestal 31" 1/2.

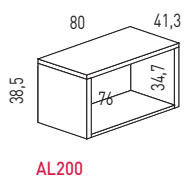

■ GENERALES FEATURES MELAMINE PEDESTALS

		GENERALES FEATURES MELAMINE PEDESTALS
STRUCTURAL FEATURES	Material	Chip wood board divided in three layers, particle board with pressed synthetic resins in hot temperature. Sanding. Density 630 Kg/m ³ . Covered with mfc decorative paper. (Different thicknesses: 16 y 19 mm).
	Structure	Chip wood board covered with MFC decorative paper, 19 mm thickness and 650 Kg/m ³ density.
	Drawer	Monoblock drawer, thermoplastic moulded or 0,5 mm thick sheet metal in black finish. High resistance. Divider and pencil tray included.
	Bottom filing drawer	Multipurpose bottom part. Thermoplastic moulded or 0,5 mm thick sheet metal in black finish. Support extra castor,
	Locking system. Security	Anti-tilt mechanism included in lock system. Security system to avoid opening more than two drawers at the same time.
		Three-drawer mobile pedestals do not have this option
	Interchangeable locks	Two position lock. Closed and locked. 1 key available to provide maximum security.
	Castors	Standard castors. Only for mobile pedestals.
	5th castor for filing drawer	Better stability and functionality. Only available in mobile pedestals. Desk heigh pedestals don't need it.
	Gently movements. Soundproofing	Polyamide locking bar to provide silent movements. Runners Stop made of rubber.
	Slides type	Steel telescopic ball bearing slides for total extraction or Steel telescopic precision linear slides for total extraction.
Slides	Telescopic ball bearing slides made of steel, total extraction, pre-galvanized treatment, passivated and electrolytic sealed salt atmosphere resistant.	
	Steel telescopic precision linear slides for total extraction.	
COMPLEMENTARY FEATURES	Handles	Ergonomics. Zamak moulded(zinc, aluminium, magnesium, copper alloy) Silver finish.
	Dividers	Thermoplastic material. High resistant.
	Pencil tray	Thermoplastic material. High resistant.
	Frame	Metal frame suitable for all type of files.
	Tops	Materials and thickness as per the models (Mobile pedestals; Chipboard tops covered by MFC paper, 16 mm thickness and 630kg/m ³ density) MFC 16, 19, 25 o 30 mm thickness, High pressure laminate 25 mm. thickness or compact laminate 13 mm thickness.
	Drawer and filing drawer fronts	Chipboard wood board covered by MFC paper 16 mm thickness and 650kg/m ³ with PVC edges 2 mm thickness.
LAYERS FEATURES	Scratches resistance (UNE EN 14323)	≥ 1,5 N
	Spot resistance (UNE EN 14323)	≥ Grade 3. Non visible defects
	Exhaustion resistance (UNE EN 14323)	≥ Grade 3. Resistant
	Surface aspect (UNE EN 14323)	Silk texture, mate finish. Grade 4
	Edges damages (UNE EN 14323)	≤ 10 mm/m
	Points fault (UNE EN 14323)	≤ 2 mm ² /m ²
	Scratches faulty (UNE EN 14323)	≤ 20 mm ² /m ²
	Covering	Decorative paper covered by resistant melamine, specially for horizontal aplicaciones. Non fingerprints
	Covering thickness (UNE EN 14323)	Standard thickness = 120 gr. Perfect product to be used in surfaces with a constant use
	Resistance to aggressive home cleaning products without solvent (UNE EN 14323)	Good resistance to acids, alcalys and room temperature oils
	Resistance to spots (UNE 14323)	Without visible defects
	Maintenance	Easy to clean. Use PH neutral products



■ FEATURES

- 1 MFC top 16 mm thickness
- 2 Side panels 16 mm thickness
- 3 Anti-tilt mechanism system. Drawer blocked system for transport
- 4 Open-close position lock
- 5 Drawers and filing drawer with total extraction
- 6 Silent movements. Rubber runner-stop
- 7 Polyamide lateral locking bar + 20% F.G.
- 8 Standard castors.
- 9 5th castor for filing drawer to give more stability and functionality
- 10 Different combinations all in one colour or silver side panels with a colour
- 11 **Optional** pencil trays and dividers
- 12 **Optional** laminated security glass top PVB 5+5 mm thickness
- 13 Silver aluminium handles

■ MOBILE PEDESTALS PROGRAMME WITH TELESCOPIC RUNNERS. COMPLETE EXTRACTION OF THE DRAWER

- Accurate metal runners
- Monoblock with drawer made of thermoplastic or sheet metal (depending on model) with stationery tray (includes dividers)
- Models with filing drawer made of thermoplastic or sheet metal (depending on model) with a metal filing frame for A4 files
- Models with filing frame made of thermoplastic or sheet metal (depending on model) fo A4 and Folio

ALL DRAWERS

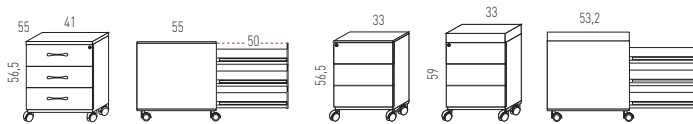

DRAWER + FILING DRAWER INCLUDING FRAME

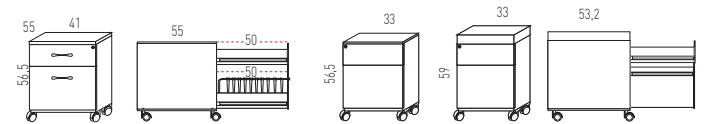

DRAWER + PULL OUT FILING FRAME

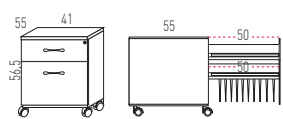

■ MOBILE PEDESTAL PROGRAMME WITH TELESCOPIC RUNNERS. DRAWER PARCIALLY OPENED.

- Simple metal runners with wheels
- Monoblock plastic drawer with stationery tray
- Models with filing drawer with a metal filing frame for A4 files

ALL DRAWERS

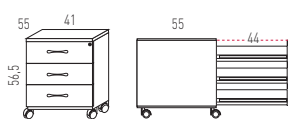

DRAWER + FILING DRAWER INCLUDING FRAME

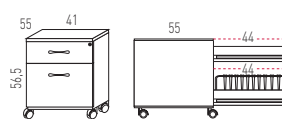

■ FINISHES (see finishes card)

MELAMINE (MFC) - 1 COLOUR

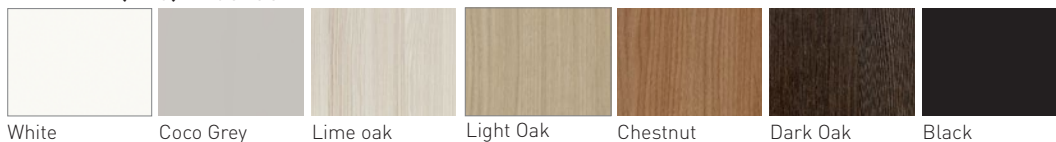

MELAMINE (MFC) - 2 COLOURS





■ FEATURES

- 1 MFC top 25 mm thickness, MFC plus top 30 mm thickness or High pressure laminate top 25 mm thickness
- 2 MFC side panels 16 mm thickness
- 3 Anti-tilt mechanism system
- 4 Open-close position lock
- 5 Drawer blocked system
- 6 Drawers and filing drawer with total extraction
- 7 Silent movements. Rubber runner-stop.
- 8 Polyamide lateral locking bar + 20% F.G.
- 9 4 inner levelers. Easy access. Distance up to +20 mm
- 10 **Optional** pencil trays and dividers
- 11 Silver aluminium handles

■ DESK HEIGHT PEDESTALS WITH TELESCOPIC RUNNERS. COMPLETE EXTRACTION OF THE DRAWER PROGRAMME

- Accurate metal runners
- Monoblock plastic drawer with stationery tray (includes dividers)
- Models with filing drawer with a metal filing frame for A4 files
- Models with filing frame fo A4 and Folio

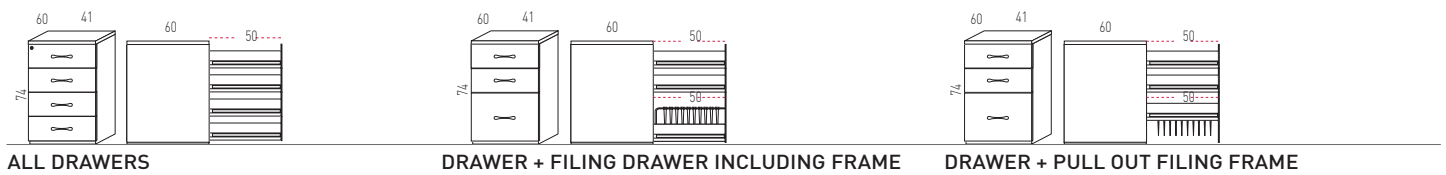

ALL DRAWERS

DRAWER + FILING DRAWER INCLUDING FRAME

DRAWER + PULL OUT FILING FRAME



ALL DRAWERS

DRAWER + PULL OUT FILING FRAME

■ FINISHES

MELAMINE (MFC) - 1 COLOUR

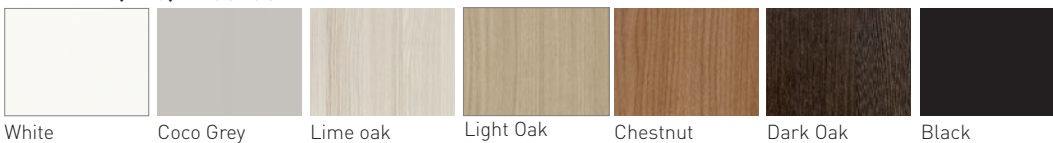

White

Coco Grey

Lime oak

Light Oak

Chestnut

Dark Oak

Black

MELAMINE (MFC) - 2 COLOURS



Silver/White

Silver/Chestnut

(see finishes card)

For projects that require the **PERSONAL STORAGE UNITS – 113CM HEIGHT PEDESTAL**, consult **SALES DEPARTMENT**.

PERSONAL STORAGE UNITS – 113CM HEIGHT PEDESTAL

Model with shelves

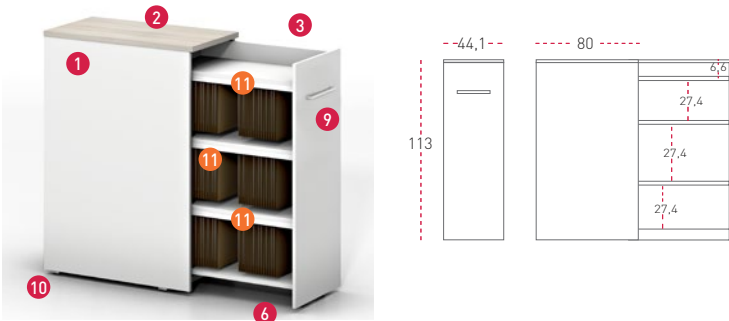

Model with shelf and drawers

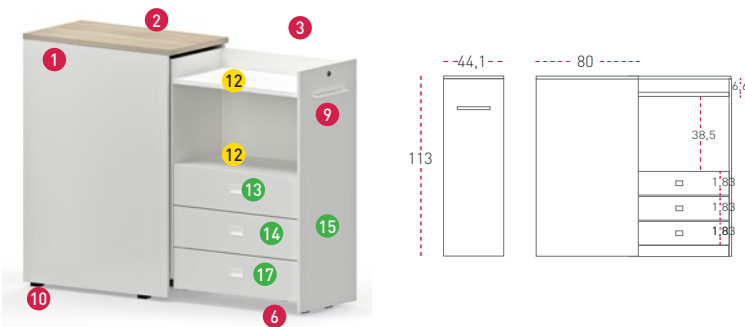

Model with shelf + drawer + filing drawer

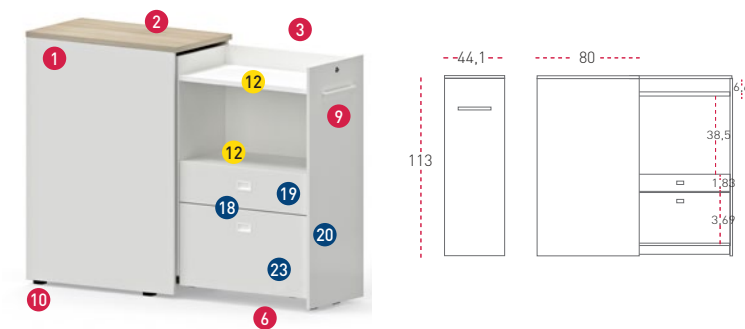

FINISHES (see finishes card)

MELAMINE (MFC)

Carcass, Door and Drawers



White

Top



White



Lime Oak



Chestnut

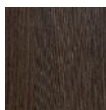

Dark Oak

ALL METAL

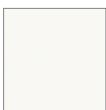

White

FEATURES

All models

- 1 Storage unit carcass made of 19mm thick MFC (front and back panel 16mm thick)
- 2 Top and bottom shelves made of 25mm thick MFC
- 3 Pull out module using full extraction runners (maximum extraction: 70cm)
- 4 Reinforced module to increase stability when the unit is opened.
- 5 Smooth and silent closing runners
- 6 35mm diameter black castor to allow easy opening of the module
- 7 Lock included
- 8 Smooth and silent closing runners (soft/self-closing runners available as an option)
- 9 Zamak handle on door. White finish.
- 10 Anti humidity feet with levellers. Black Finish

Model with shelves

- 11 Steel shelves 0.7mm thick with double lower rail to allow hanging files

Model with Shelves and drawers

- 12 MFC Shelves
- 13 Inset Zamak handle on drawers. White finish.
- 14 Completely accessible drawers
- 15 Full extraction runners on drawers
- 16 Black steel drawer case 0.7mm thick.
- 17 16mm thick MFC drawer fronts

Model with Shelves + drawer + filing drawer

- 12 MFC Shelves
- 18 Inset Zamak handle on drawers. White finish.
- 19 Completely accessible drawers and filing drawer
- 20 Full extraction runners on drawers
- 21 Black steel filing drawer case 0.7mm thick.
- 22 Metal adapter included to use different sizes of files on filing drawer
- 23 16mm thick MFC drawer and filing drawer fronts

For projects that require the **PULL OUT PEDESTALS WITH METAL DRAWER AND RUNNERS**, consult **SALES DEPARTMENT**.

PULL OUT PEDESTALS WITH METAL DRAWER AND RUNNERS

■ **FEATURES**

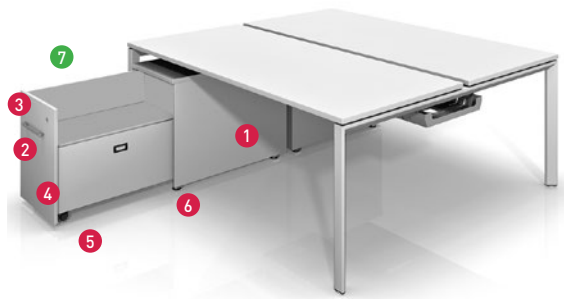

- 1 MFC structure available in different finishes. Square caps with levelers.
- 2 Large handle.
- 3 Security key.
- 4 Totally extractions runners
- 5 Pedestal drawer, soft castors, 37mm diameter. Lockable.
- 6 Square caps with levelers.

2 models:

- 7 Top shelf + Black steel filing drawer case 0.7mm thick. with stabilizing runner. Inlaid handles
- 8 Top shelf + 2 Black steel drawers case 0.7mm thick.. Optional dividers. Inlaid handles.



LAYOUT EXAMPLES

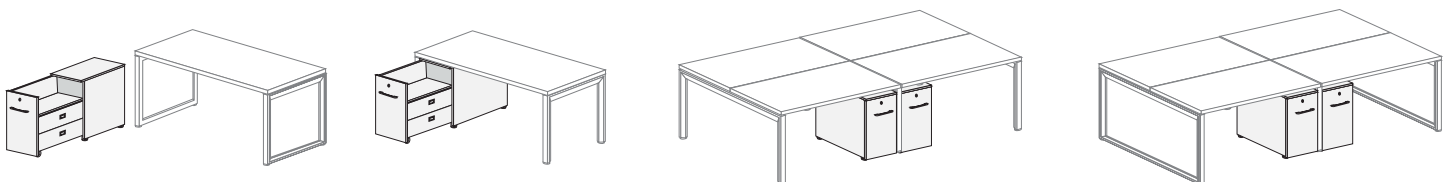

To use pull out pedestals as a desk support, please check VITAL PLUS ST operative desks range to see all available models.

To use pull out pedestals under the desks with other accessories such as modesty panels, electrification channels and so on, please check first with sales team to be sure that all accessories and sizes ordered are the correct ones.

■ **FINISHES**

MELAMINE (MFC) - 1 COLOUR

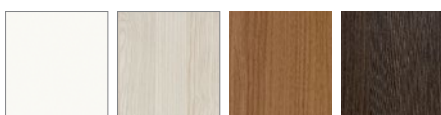

White Lime Oak Chestnut Dark Oak

STORAGE UNITS



- ① Sliding door
- ② Integrated runner system, Surface totally usable Embossed handles
- ③ Height adjustable shelves each 32 mm
- ④ Fitted handles by injected aluminium
- ⑤ Drawers with total extraction
- ⑥ Cable access \varnothing 58 cm

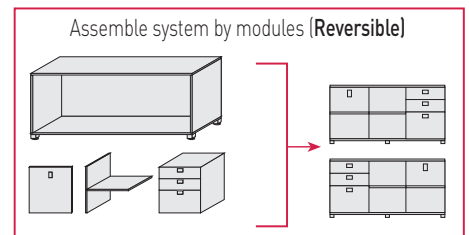

STORAGE UNITS

· 2 sliding doors

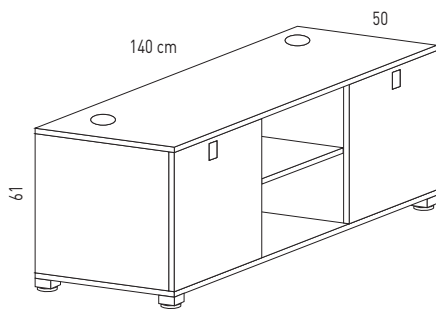

· Drawers/Door

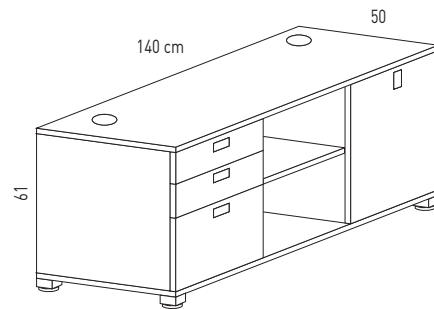

HUTCH IN OPTION

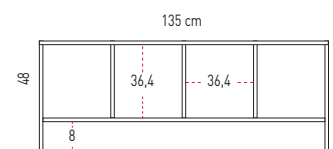
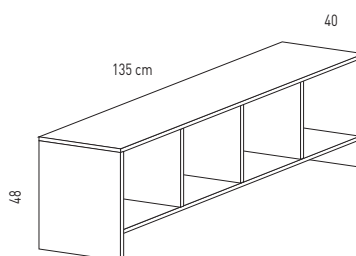

■ STORAGE UNITS

MFC frame composed by reversible modular system with shelves, sliding doors and or drawers and filing drawers. Two different models:

· Model with shelves and sliding doors

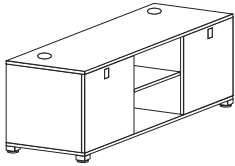

- ① Top and base, 25 mm thickness
- ② Inner side panels, mfc 19 mm thickness. Back panel 16 mm thickness
- ③ Shelves are manufactured by mfc 16 mm thickness. Height adjustable every 32 mm
- ④ Ergonomic handles produced with Zamak, aluminium alloy.
- ⑤ Levelers supports, inner easy access +20 mm
- ⑥ Anti skid PVC cap included in the levellers
- ⑦ 2 cable access Ø80 mm, PVC top cover
- ⑧ MFC sliding door 16 mm thickness
- ⑨ Thermoplastic runner inserted in the base. Plane base without any obstacle

· Model with shelves and sliding doors

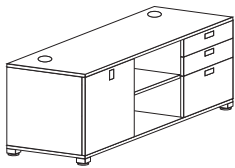
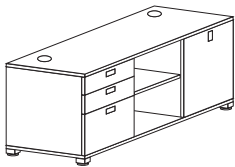

- ① Top and base, 25 mm thickness
- ② Inner side panels, MFC 19 mm thickness. Back panel 16 mm thickness
- ③ Shelves are manufactured by mfc 16 mm thickness. Height adjustable every 32 mm
- ④ Ergonomic handles produced with Zamak, aluminium alloy.
- ⑤ **Drawers:** Top security lock. Two positions, open and close. An unique key.
- ⑥ Levelers supports, inner easy access +20 mm
- ⑦ Anti skid PVC cap included in the levellers
- ⑧ 2 cable access Ø80 mm, PVC top cover
- ⑨ Drawers and filing frames with MFC front panel 16 mm thickness
- ⑩ Drawers and filing frames with telescopic steel runners totally opened
- ⑪ Anti tilt mechanism (avoiding to open all drawers at the same time)

· Optional hutches for desk-support credenza units.

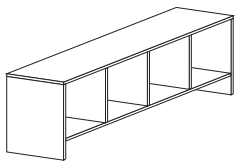

- ① Optional hutch manufactured by MFC 19 mm thickness. Inner space 36,4 x 36,4 cm

















■ FINISHES

MFC



White Coco Grey Lime Oak Light Oak Chestnut Dark Oak Black

(see finishes card)

BUCKS - MFC							
1 COLOUR							
Carcass	White	Lime oak	Light Oak	Chestnut	Coco Grey	Dark Oak	Black
Handle	White	White	White	White	White	Black	Black
Picture							
2 COLOURS							
Carcass	White						
Front	Lime oak		Light Oak	Chestnut	Dark Oak		
Handle	White		White	White	Black		
Picture							
Carcass	Silver						
Front	White	Lime oak	Light Oak	Chestnut	Coco Grey		
Handle	White	Silver	Silver	Silver	Silver		
Picture							



MATERIALS

Maximum use of materials to eliminate and minimize scraps. Use of recyclable and recycled materials in those components that do not affect the functionality and durability.

62,06%
RECYCLED
MATERIALS



PRODUCTION

Maximum optimization of energy use. Minimal environmental impact. Last generation technological systems. Zero discharge of wastewater. No VOC coatings. Processes free of heavy metals, phosphates, OC and COD.

100%
RECYCLABLE
ALUMINIUM, STEEL
& WOOD



TRANSPORT

Detachable systems. Volumes that facilitate the optimization of space. Maximum reduction of energy consumption by transport.

100%
RECYCLABLE
PACKAGE AND THINNER
FREE



USE

Quality and warranty. Long lasting. Replacements available.

EASY
TO CLEAN
AND MAINTAIN



DISPOSAL

Waste reduction. Supplier-manufacturer packaging reuse system. Components are easy to be separated. Inks in packaging are water-based, without solvents.

94,49%
RECYCLABLE
MATERIALS

■ **CERTIFICATES AND REFERENCES**

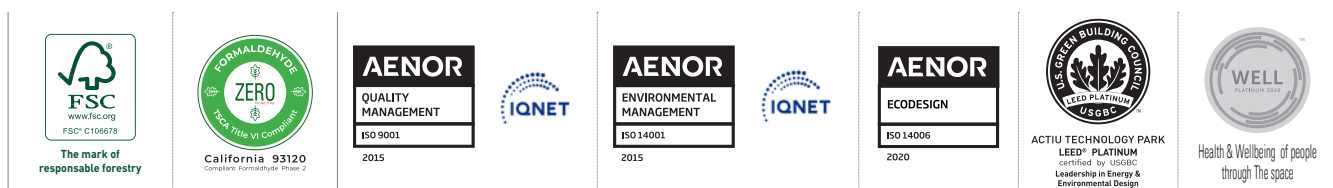

■ **STANDARS**

PEDESTALS MELAMINE has passed tests done in our technical department as well as the tests done in **AIDIMA** the Technological Institute for furniture. The tests correspond to **UNE** standards and Filing system cabinets:

- **UNE-EN 14073-2:2005**. Office furniture. Storage furniture. Part 2: Safety requirements.
- **UNE-EN 14073-3:2005**. Office furniture. Storage furniture. Part 3: Test methods for the determination of stability and strength of the structure.
- **UNE-EN 14074:2005**. Office furniture. Tables and desks and storage furniture. Test methods for the determination of strength and durability of moving parts.